



LIGHT

Education

NOVAH® EDU



The role of library is gradually changing from the collection-centered to the reader-centered nowadays. So it is more important to do the reasonable space design of the whole library. The informal learning space has been paid more attention to, and it has become a topic for librarians to create a more comfortable and belonging formal reading area, and to provide more humanized study rooms.







① One-button-switch lighting is designed to support reading and self-study, it can also protect the eyesight.

② Modular sockets can meet the charging requirements of mobile devices.



③ Acrylic screen can reduce disturbing from vision and hearing.



④ The hook can hang personal belongings.

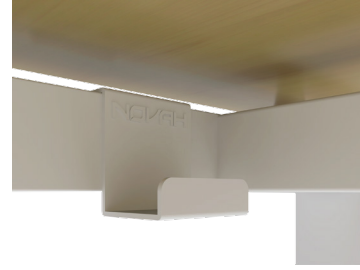

⑤ The middle foot can fully support the cable management.



⑥ Adjustable slides ensure the stability on the ground.



Specifications

Six-person

W2400×D1200×H1255 mm

Desktop screen

W1800×D6×H250 mm

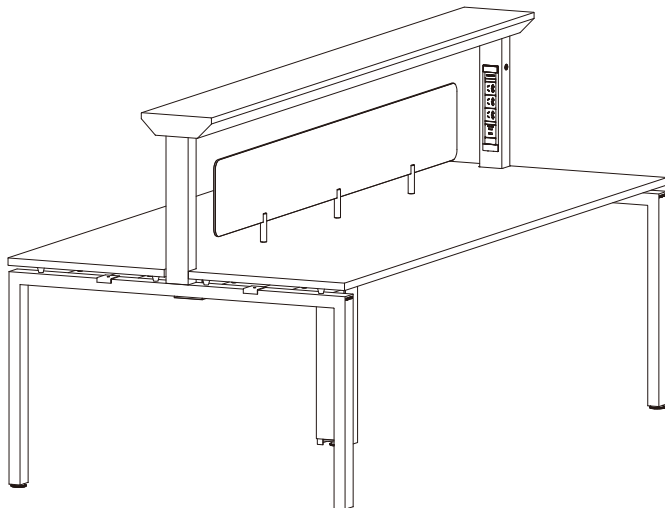

Four-person

W1600×D1200×H1255 mm

Desktop screen

W1200×D6×H250 mm

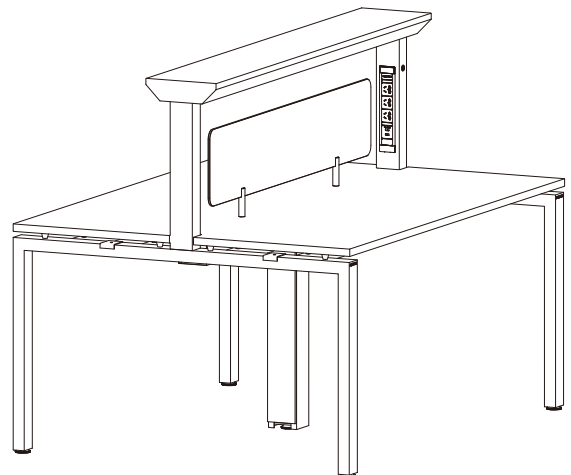

Materials & Colors

MFC Tabletop



M1

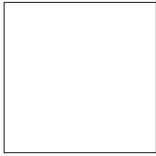

M2



M7



M16

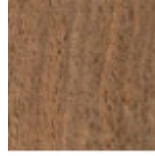

M18



M20



M21



M22



M23

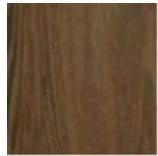

M24

Tabletop Wood

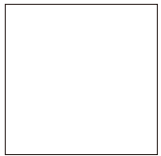

BT3



W4



W5

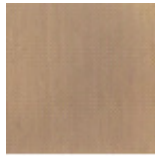

W10

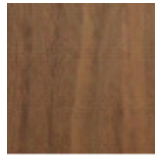

W25

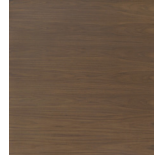

W25B



W26

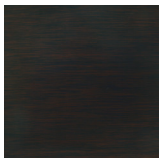

W26B



W28

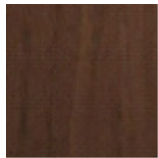

W29

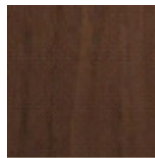

W29B

Steel Frame



K17



K20



K5

Acrylic Screen

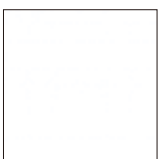

A1



A2

LIGHT



NOVAH System Technology Co.,Ltd.

Tel: 400-115-1688

Web: www.novah.cc

Mail: int@novah.cc

NOVAH[®]EDU